



The PLAN range offers a contemporary alternative to the traditional panel radiator. Achieving a radiator range that has a minimalist feel, combining good looks with leading performance.

The sleek flat front panel design of the PLAN offers a contemporary alternative to the traditional panel radiator. Whilst maintaining all of the benefits, the PLAN PLUS model takes this modern styling one step further with a decorative, rather than flat, front panel. Both models feature side panels and top grille.

The PLAN Vertical and PLAN PLUS Vertical both feature the same front panel design as the PLAN & PLAN PLUS, however, have the addition of curved rather than straight side panels.













- Available in 5 heights and 14 lengths, ranging from 400mm to 3000mm, the PLAN range comes in over 136 stocked sizes, while the PLUS range is offered in 94 stocked sizes
- Both models feature Type 11, Type 21 and Type 22 profiles, with the PLAN additionally available as a Type 33 profile (vertical models are only available in Type 21 & 22)



**PLAN, PLAN PLUS & VERTICAL**

# PLAN & PLAN PLUS

## General specification & technical information

-  **CERTIFICATION**  
Manufactured and tested to BS EN 442 & EN 442. Carries the CE & UKCA Mark. Produced under a quality management system - ISO 9001:2015, environmental management system - ISO 14001:2015 and Occupational health and safety management system - OHSAS 18001.
-  **GUARANTEE**  
10 year guarantee from date of purchase against manufacturing defects.
-  **COLOUR**  
All radiators are de-greased, phosphated and primer coated. An epoxy polyester finishing coat in white (RAL 9016) is applied to all front and rear surfaces.
-  **ACCESSORIES**  
Touch up paint is available to order.
-  **SYSTEM**  
2 pipe pumped indirect domestic and commercial heating applications.
-  **CONNECTIONS**  
4 x 1/2" BSP. Please see below.
-  **AIR VENTS**  
Air vent and plug packs are included in the packaging.
-  **OPERATING PRESSURES**  
Tested to a pressure of 10.5 bar - 13 bar. Working pressure of up to 8 bar - 10 bar.
-  **OPERATING TEMPERATURE**  
Maximum 100°C.
-  **DELIVERY**  
2 - 5 working days. Non-stocked items: 4 - 5 weeks.
-  **VALVES**  
Please see page 225.
-  **BIM**  
Visit our website to download the BIM components [www.myson.co.uk/bim](http://www.myson.co.uk/bim)

For more general information, please see page 264.

### Weights & water contents per metre length

Type	Nominal Height (mm)							
	300		400		500		600	
	Weight (kg)	Water Content (l)	Weight (kg)	Water Content (l)	Weight (kg)	Water Content (l)	Weight (kg)	Water Content (l)
11	11.70	1.50	16.10	2.20	20.50	2.90	24.80	3.40
21	-	-	-	-	23.70*	5.20*	33.70	6.10
22	19.10	3.20	25.10	4.20	31.50	5.20	38.00	6.10
33*	26.90	5.10	36.70	6.30	42.20	7.50	56.40	8.80

\*PLAN only.

### n-Coefficients

Type	Nominal Height (mm)			
	300	400	500	600
11	1.2820	1.2824	1.2827	1.2831
21	-	-	1.2907*	1.2967
22	1.3000	1.3098	1.3197	1.3295
33*	1.3159	1.3245	1.3331	1.3417

\*PLAN only.

### Connection options

4 x 1/2" BSP

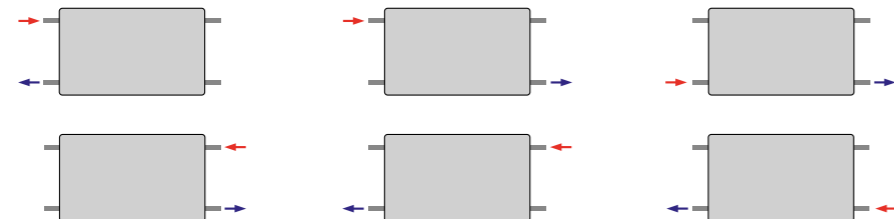

### Mounting positions & dimensions

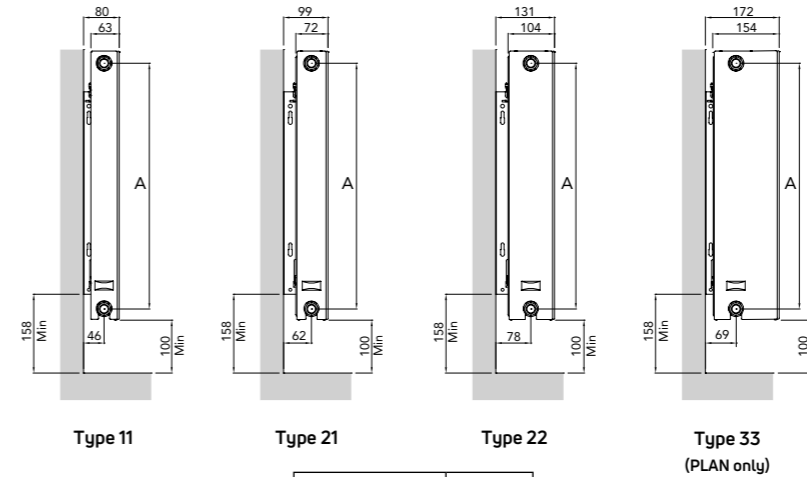

Nominal Height (mm)	A (mm)
300	250
400	350
500	450
600	550

### Top View

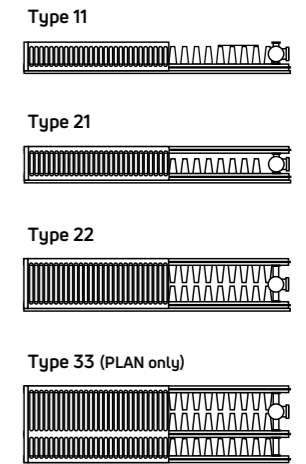

### Bracket positions & dimensions

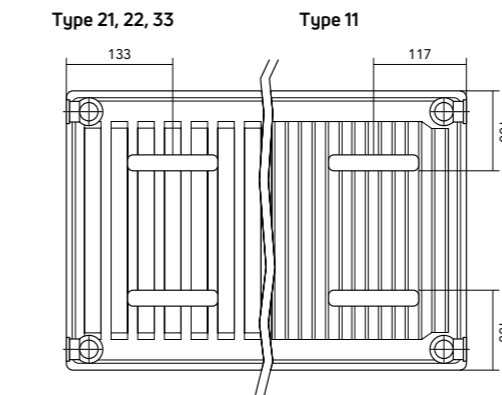

Bracket for use on - Type 11 and 33

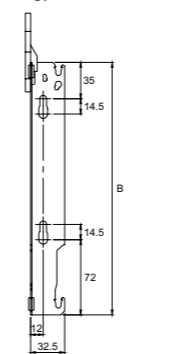

Bracket for use on - Type 21 and 22

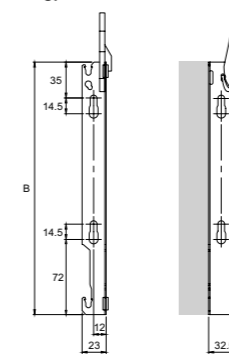

Nominal Height (mm)	B (mm)
300	151
400	241
500	341
600	441

### Floor brackets

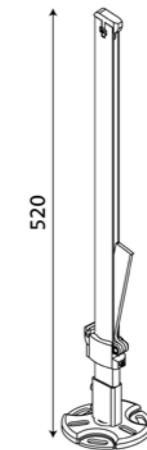

#### Floor brackets for all types:

Radiator to wall distance: Any  
Maximum load of a single bracket:  
Vertically - 180kg  
Pulling - 35kg

Order Code: RH033 (single piece)

Height 300 - 700mm	
Radiator length (mm)	Quantity of floor brackets*
400 - 1600	2
1800 - 2300	3
2400 - 2600	4
2700 - 3000	5





\*The floor brackets will support the radiators, however, in certain instances the brackets will flex and where possible the radiator should be fixed to the wall using the top bracket.







NB: ALL measurements are nominal.



# PLAN VERTICAL & PLAN PLUS VERTICAL

## General specification & technical information

-  **CERTIFICATION**  
Manufactured and tested to BS EN 442 & EN 442. Carries the CE & UKCA Mark. Produced under a quality management system - ISO 9001:2015, environmental management system - ISO 14001:2015 and Occupational health and safety management system - ISO 45001:2018.
-  **GUARANTEE**  
10 year guarantee from date of purchase against manufacturing defects.
-  **COLOUR**  
All radiators are de-greased, phosphated and primer coated. An epoxy polyester finishing coat in white (RAL 9016) is applied to all front and rear surfaces.
-  **ACCESSORIES**  
Touch up paint is available to order.
-  **SYSTEM**  
2 pipe pumped indirect domestic and commercial heating applications.

-  **CONNECTIONS**  
6 x 1/2" BSP. Please see below.
-  **AIR VENTS**  
Air vent and plug packs are included in the packaging.
-  **OPERATING PRESSURES**  
Tested to a pressure of 8 bar. Working pressure of up to 6 bar.
-  **OPERATING TEMPERATURE**  
Maximum 100°C.
-  **DELIVERY**  
2 - 5 working days. Non-stocked items: 4 - 5 weeks.
-  **VALVES**  
Please see page 58.

For more general information, please see page 264.

### Weights & water contents per metre length

Type	Nominal Height (mm)			
	1800		1950	
	Weight (kg)	Water Content (l)	Weight (kg)	Water Content (l)
21	100.27	21.47	109.33	24.13
22	111.60	21.73	123.73	23.47

### n-Coefficients

Type	Nominal Height (mm)	
	1800	1950
21	1.3192	1.3231
22	1.3387	1.4255

### Connection options

6 x 1/2" BSP (15/21)

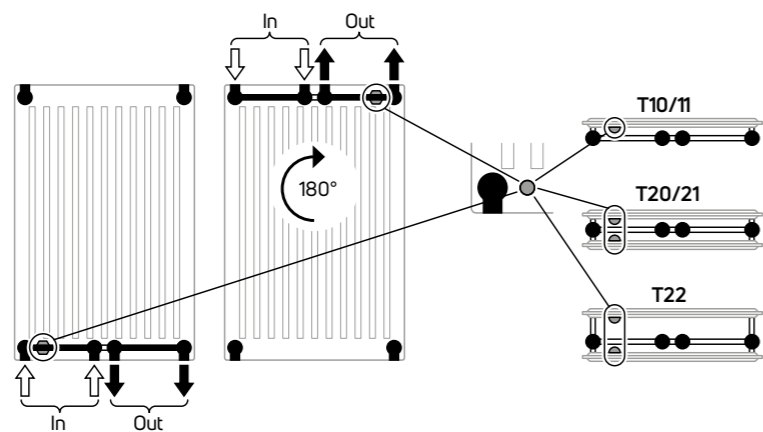

### Mounting positions & dimensions

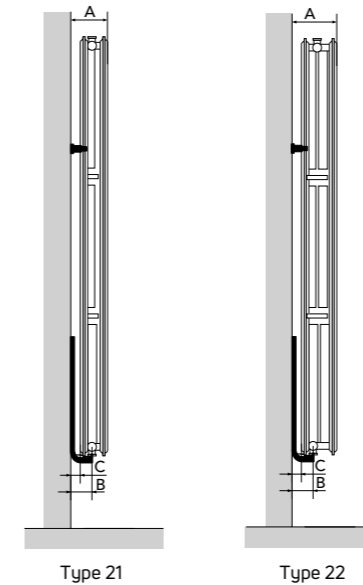

	Type	
	21	22
A (mm)	109	134
B (mm)	65	65
C (mm)	25	25

Length (mm)	D	E
	(mm)	(mm)
300	244	320
450	394	470
600	544	620
750	694	770

### Top View

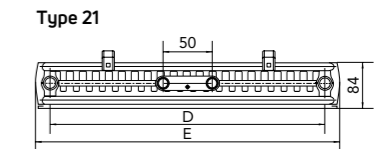

### Type 22

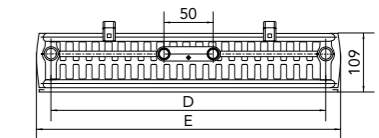

### Bracket positions & dimensions

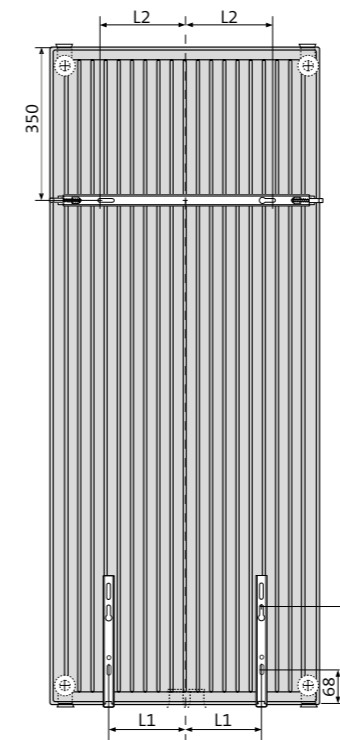

Length (mm)	L <sub>1</sub>	L <sub>2</sub>
	(mm)	(mm)
300	60	75
450	135	125
600	210	200
750	285	250

### Brackets

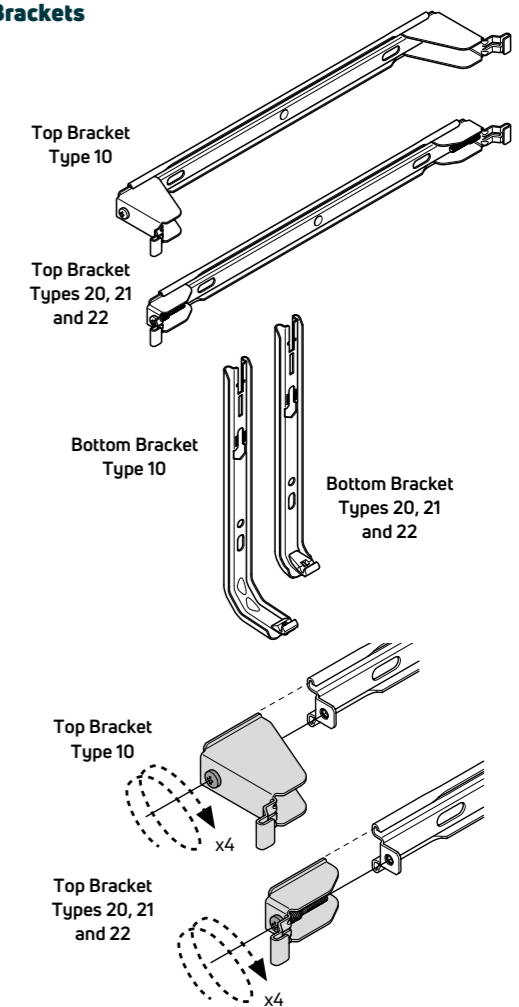

NB: All measurements are nominal.

PREMIUM PANEL RADIATORS

PREMIUM PANEL RADIATORS

# PLAN VERTICAL & PLAN PLUS VERTICAL

## Heat outputs

Type 21

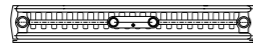

Type 22

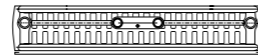

### PLAN VERTICAL

Nominal Height	Nominal Length (mm)	Heat Outputs @ ΔT 50°C		Heat Outputs @ ΔT 30°C		Order Code	Heat Outputs @ ΔT 50°C		Heat Outputs @ ΔT 30°C		Order Code
		Watts	Btu/h	Watts	Btu/h		Watts	Btu/h	Watts	Btu/h	
1800mm	300	886	3023	452	1542	180 PX 30G	1046	3569	528	1802	180 PD 30G
	450	1329	4535	678	2313	180 PX 45G	1569	5353	792	2702	180 PD 45G
	600	1772	6046	903	3081	180 PX 60G	2092	7138	1056	3603	180 PD 60G
	750	2215	7558	1129	3852	180 PX 75G	2615	8922	1320	4504	180 PD 75G
1950mm	300	936	3194	476	1624	195 PX 30G	1103	3763	532	1815	195 PD 30G*
	450	1405	4794	714	2436	195 PX 45G*	1654	5643	798	2723	195 PD 45G
	600	1873	6391	953	3252	195 PX 60G*	2205	7523	1065	3634	195 PD 60G
	750	2341	7987	1191	4064	195 PX 75G	2756	9403	1331	4541	195 PD 75G

Type 21



Type 22

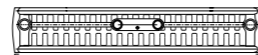

### PLAN PLUS VERTICAL

Nominal Height	Nominal Length (mm)	Heat Outputs @ ΔT 50°C		Heat Outputs @ ΔT 30°C		Order Code	Heat Outputs @ ΔT 50°C		Heat Outputs @ ΔT 30°C		Order Code
		Watts	Btu/h	Watts	Btu/h		Watts	Btu/h	Watts	Btu/h	
1800mm	300	886	3023	452	1542	180 PPX 30G*	1046	3569	528	1802	180 PPD 30G
	450	1329	4535	678	2313	180 PPX 45G	1569	5353	792	2702	180 PPD 45G
	600	1772	6046	903	3081	180 PPX 60G	2092	7138	1056	3603	180 PPD 60G
	750	2215	7558	1129	3852	180 PPX 75G*	2615	8922	1320	4504	180 PPD 75G
1950mm	300	936	3194	476	1624	195 PPX 30G*	1103	3763	532	1815	195 PPD 30G*
	450	1405	4794	714	2436	195 PPX 45G*	1654	5643	798	2723	195 PPD 45G*
	600	1873	6391	953	3252	195 PPX 60G*	2205	7523	1065	3634	195 PPD 60G
	750	2341	7987	1191	4064	195 PPX 75G	2756	9403	1331	4541	195 PPD 75G

\*Non-stock - made to order only.

## Accessories



Product	Finish	Order Code
<b>VALVE SETS (Includes a nut &amp; olive pack)</b>		
Two-pipe Valve Set (Straight)**	White	VSWHST
Two-pipe Valve Set (Straight)**	Chrome	VSCHST
Two-pipe Valve Set (Angle)**	White	VSWHAN
Two-pipe Valve Set (Angle)**	Chrome	VSCHAN
<b>TOWEL BARS</b>		
300mm	Matt Brushed Stainless Steel	PLANBAR300
450mm	Matt Brushed Stainless Steel	PLANBAR450
600mm	Matt Brushed Stainless Steel	PLANBAR600
750mm	Matt Brushed Stainless Steel	PLANBAR750



\*\*Not to be used for top connection.

