

Register your warranty
online at www.myson.co.uk



MYSON Eastern Avenue, Team Valley, Gateshead, Tyne & Wear NE11 0PG, UK
T: 0845 402 3434, F: 0191 491 7568, sales@myson.co.uk, www.myson.co.uk

FINESSE

INSTALLATION, OPERATING,
& INSTRUCTION MANUAL

PLEASE LEAVE THIS MANUAL WITH THE END USER

Class I - 230V - 50 Hz

Contents

1.0	Warnings & Safety Information	03
2.0	General Information	05
3.0	Warranty	05
4.0	Installation	06
5.0	Maintenance, Repair & Disposal	07
6.0	Waste Disposal According to The WEEE Directive (2012/19/EU)	08
7.0	Operation	08
	7.1 Stand Alone Radiator	09
	7.2 Radiator Connected to a TOUCH4 Central Programmer	09
	7.3 Other Functions	10
8.0	Parameter Menu	11
9.0	Radiator Connected to the TOUCH4 Programmer	11
10.0	Technical Characteristics	13
11.0	Eco Directive Characteristics	14

1.0 Warnings & Safety Information

SAFETY INFORMATION

This appliance can be used by children aged from 8 years and above and persons with reduced physical, sensory or mental capabilities or lack of experience and knowledge, if they have been given supervision or instruction concerning use of the appliance in a safe way and understand the hazards involved.

Children shall not play with the appliance. Cleaning and user maintenance shall not be made by children unless they are older than 8 and supervised.

Keep the appliance and its cord out of reach of children aged less than 8 years.

Children of less than 3 years should be kept away from the unit unless continuously supervised.

Children aged from 3 years and less than 8 years shall only switch on/off the appliance provided that it has been placed or installed in its normal operating position and they have been given supervision or instruction concerning use of the appliance in a safe way and understand the hazards involved.

Children aged from 3 years and less than 8 years shall not plug in, regulate, clean the appliance or perform user maintenance.

1.0 Warnings & Safety Information (cont...)

CAUTION

Some parts of this product can become very hot and cause burns. Particular attention has to be given where children and vulnerable people are present.

 In order to avoid overheating, do not cover the radiator. "Do not cover" means that the radiator must not be used for drying clothes, for example, by placing them directly on the radiator.

 **IMPORTANT SAFETY INSTRUCTIONS!**

Before starting work disconnect power supply!

All installation work and wiring work related to the radiators, thermostats and programmers must be carried out only when de-energized.

The appliance should be installed by and commissioned by qualified professionals only.

Make sure to adhere to valid safety regulations.

Any repairs or maintenance within the warranty period should be carried out only by approved service engineers confirmed by MYSON.

For the correct installation of radiators it is essential that the fixing of the radiator is carried out in such a way that it is suitable for intended use AND predictable misuse. A number of elements need to be taken into consideration including the fixing method used to secure the radiator to the wall, the type and condition of the wall itself, and any additional potential forces or weights, prior to finalising installation. **IN ALL CASES IT IS STRONGLY RECOMMENDED THAT A SUITABLY QUALIFIED PROFESSIONAL INSTALLER OR SIMILAR TRADESPERSON CARRIES OUT THE INSTALLATION.**

PLEASE NOTE: The fixing materials provided are only intended for installation on walls made of solid wood, bricks, concrete or on timber-frame stud walls where the fixing is into the timber. All walls being considered should have no more than a maximum of 3mm wall finishing. For walls made of other materials, for example hollow bricks, please consult your installer and/or specialist supplier. **ONCE AGAIN, IF YOU ARE UNSURE, IT IS STRONGLY RECOMMENDED THAT A SUITABLY QUALIFIED PROFESSIONAL INSTALLER OR SIMILAR TRADESPERSON CARRIES OUT THE INSTALLATION.**

The radiator is equipped with an overheat protection that cannot be reset (melt fuse). This overheat protection disconnects the current if the radiator becomes too hot (e.g. when covered).

If the supply cord is damaged, it must be replaced by the manufacturer, his service agent or similar qualified persons in order to avoid a hazard.

The radiator is filled with an exact amount of environmental friendly vegetable oil. Any repairs that require the radiator to be opened shall therefore only be carried out by the manufacturer or his approved agent. Please contact MYSON in case of leakage.

2.0 General Information

- This appliance is a sealed electric radiator designed for fixed wall-mounted installation.
- This appliance conforms to the standards EN 60335-1 and EN 60335-2-30.
- This appliance is class I and splash resistant (IP44).
- This appliance complies with the European Directive 2004/108/EC (CE Marking on all appliances).
- This unit is supplied complete with a connection cable and wall brackets.

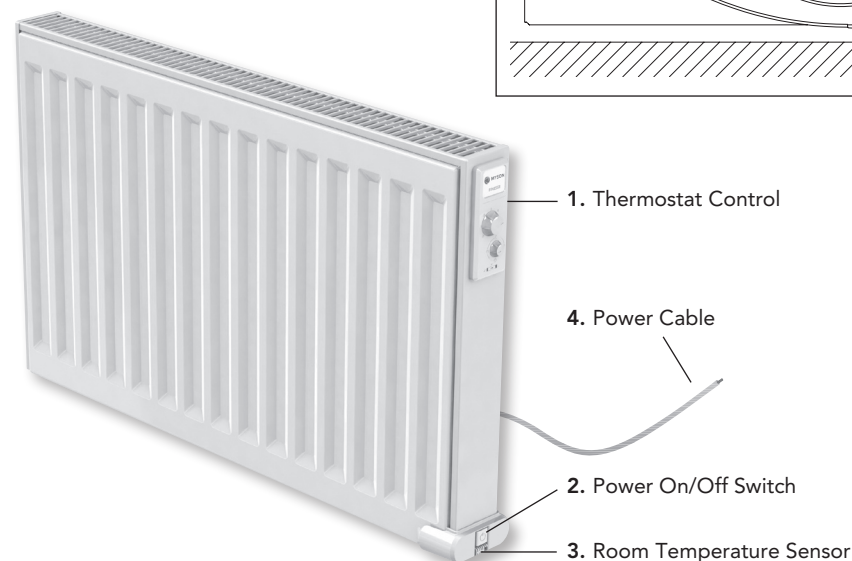
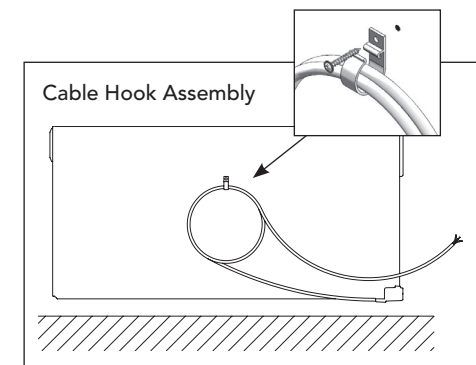

3.0 Warranty

The product is covered by a 2 year warranty from date of purchase.



4.0 Installation

POSITIONING

- The radiator must be positioned horizontally, the right way up on the wall in order for it to function correctly. Never switch the radiator on in any other position as this will damage the electrical element.
- The radiator must be positioned according to the applicable standards and the minimum distances as specified in figure 1 should be carefully observed.
- The radiator must not be located underneath an electric socket.

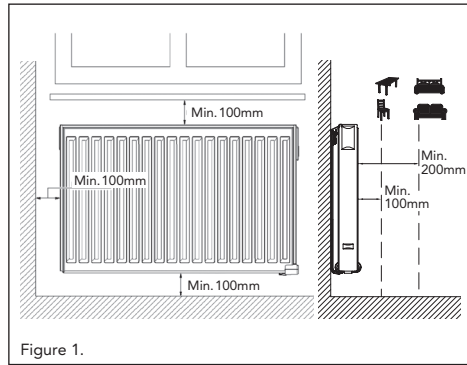

Figure 1.

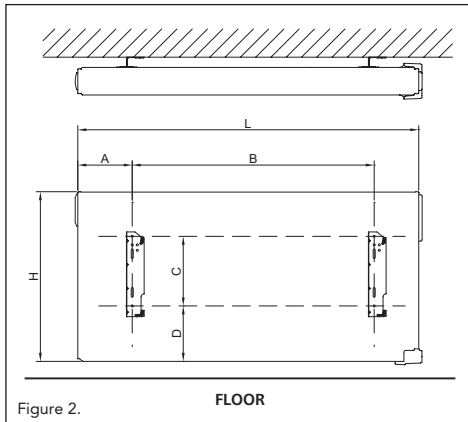

Figure 2.

Safety Clip-on Brackets

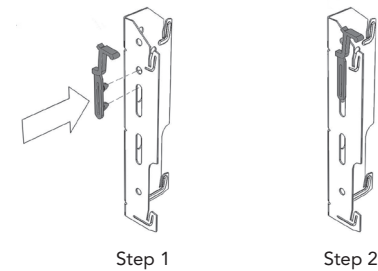

Figure 3.

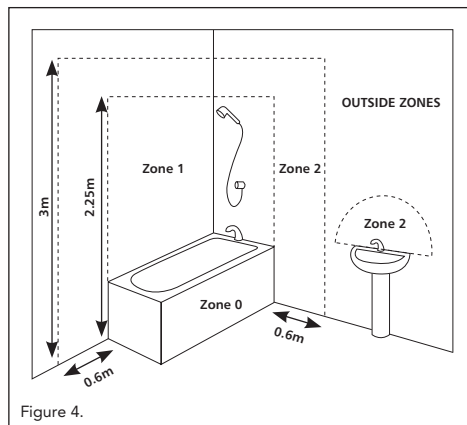

Figure 4.

- This product is splash resistant with an IP44 rating. This must be considered when installing in a location containing a bath or shower, as defined by BS 7671.
- The radiator may be positioned in zone 2 (figure 4) of the bathroom, in so far as no operating controls (button, switch, etc.) are in reach of persons in the bath or under the shower.

FIXING

- Mark out the distance between the brackets and the positions for the screw holes as shown in figure 2 and the dimension tables at the top of page 7, and ensure the safety clips are used (see figure 3).

4.0 Installation (cont...)

FINESSE Double Panel (refer to figure 2)

Height (mm)	300	500
C	135	205
D	90	163

Length (mm)	400	500	650	800	950	1000	1250	1300	1600	2000
A	160	160	160	160	160	160	160	160	160	160
B	101	203	355	508	660	711	965	1016	1320	1727

STAND ALONE CONNECTION

- The electrical installation must comply with local or national regulations.
- The radiator must be connected to the electrical supply, using a switched fused spur with 3mm separation on all poles.
- If the radiator is installed in a bathroom or shower room, it must be protected with a residual current device (RCD) with a rated residual current not exceeding 30 mA.
- The radiator should be connected by a suitable and qualified electrician. Please refer to the wiring diagram (figure 5) for the connection of the radiator.

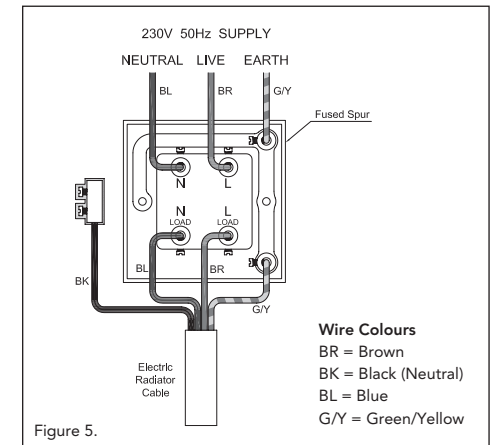

Figure 5.

5.0 Maintenance, Repair & Disposal

- Use only a damp cloth for cleaning and wiping of the radiator which should be switched off at this time.
- When scrapping the radiator, follow the regulations concerning the disposal of oil.

6.0 Waste Disposal According to The WEEE Directive (2012/19/EU)



Waste disposal according to the WEEE Directive (2012/19/EU). The symbol on the product label indicates that the product may not be handled as domestic waste, but must be sorted separately. When it reaches the end of its useful life, it shall be returned to a collection facility for electrical and electronic products. By returning the product, you will help to prevent possible negative

effects on the environment and health to which the product can contribute if it is disposed of as ordinary domestic waste. For information about recycling and collection facilities, you should contact your local authority/municipality or refuse collection service or the business from which you purchased the product. Applicable to countries where this Directive has been adopted.

7.0 Operation

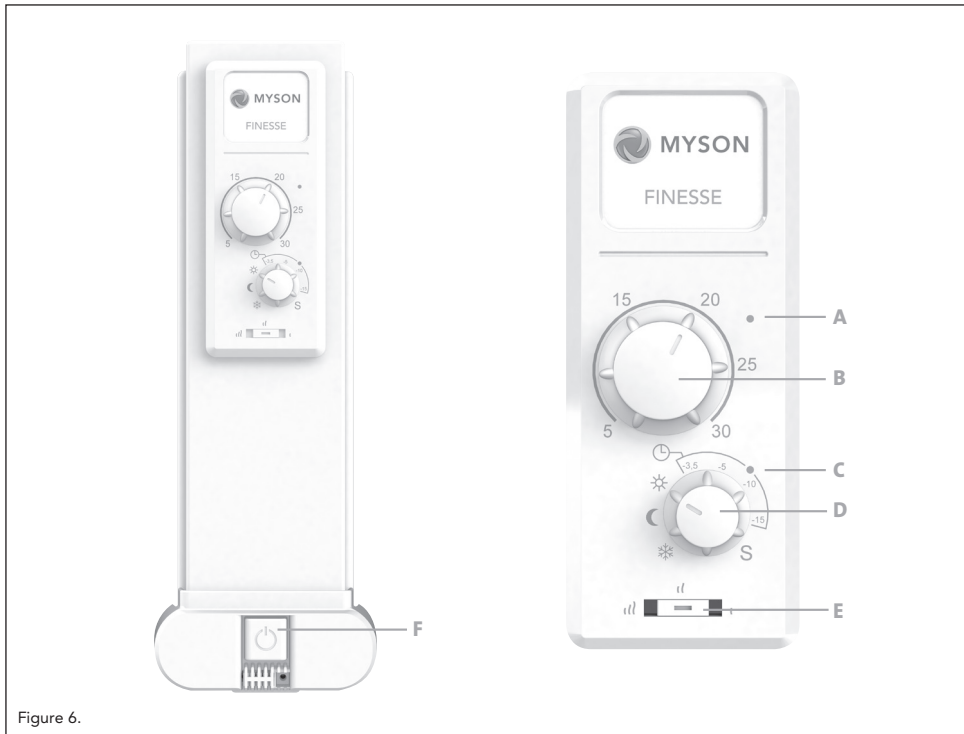

Figure 6.

- The On/Off button is located at the bottom of the control side of the radiator (F, figure 6). The radiator should only be switched "on" when it is correctly installed and

secured to the wall brackets. When the radiator is switched on, LED (A) will turn green or red depending upon the heating demand.

7.0 Operation (cont...)

7.1 STAND-ALONE RADIATOR

- Select one of the following operating modes using dial D (figure 6):

COMFORT MODE ☀

Select this mode for periods of normal occupancy.

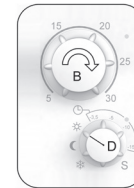

COMFORT MODE

- Turn dial "D" to the sun symbol.
- Select the required room temperature between 5 and 30°C using dial "B".

REDUCED MODE ☾

Select this mode for night-time or when the house is unoccupied for several hours. This mode will lower the temperature of the room by 3.5°C from the "Comfort mode" set temperature.

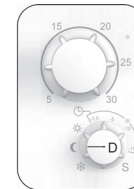

REDUCED MODE

- Turn dial "D" to the moon symbol.

FROST PROTECTION MODE ❄

This mode is to be used when the house is unoccupied for extended periods. The radiator will maintain the room temperature at 7°C.

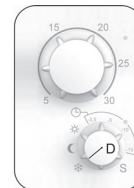

FROST PROTECTION MODE

- Turn dial "D" to the snowflake symbol.

7.2 RADIATOR CONNECTED TO A TOUCH4 CENTRAL PROGRAMMER

- When connected to a central programmer (refer to page 11), select the automatic operation mode by turning dial "D" to the clock symbol.

AUTOMATIC MODE ⌚

- This mode is intended to be used in combination with an external programmer, or the built in programmer.



AUTOMATIC MODE

- Select the desired room temperature during periods of normal occupancy between 5 and 30°C using dial "B".
- Rotate dial "D" within the area covered by the ⌚ symbol. At night or during periods of inoccupancy, the radiator will reduce its temperature output. The value on this scale indicates the desired temperature reduction.

Example: If the comfort temperature is set to 21°C and dial "D" is set to -5, then the radiator will give a room temperature of 16°C in this case.

7.0 Operation (cont...)

7.3 OTHER FUNCTIONS

- The switch (E, figure 6) at the bottom of the control panel can be used to limit the output (surface temperature) of the heating element in the front panel.



Note: When considering the permanent use of the radiator at 60°C or 75°C maximum, the following correction factor should be applied for the output.

E SWITCH	SURFACE TEMP.	SINGLE PANEL	DOUBLE PANEL
▮	~ 60°C max	~ 0.55	~ 0.80
▮▮	~ 75°C max	~ 0.70	~ 0.90
▮▮▮	~ 90°C max	1	1

E.g. a 1,000 Watt single-panel with the E switch on the 75°C position will deliver max. 700 Watts. A 1,000 Watt double panel with the E switch on the 60°C position will deliver max. 800 Watts. These values should be considered when selecting the number and type of panels to cover the calculated heat losses.

- Two LED indicators (A and C, figure 6) indicate the working mode of the radiator.

LED A	
GREEN	Radiator switched on
RED	Radiator heating
RED BLINKING	Sensor problem
LED C (only when external programmer connected)	
OFF	Comfort mode
GREEN BLINKING (CYCLE OF 4-BLINKS THEN PAUSE, 4-BLINKS, REPEATED).	Reduced mode

KEY LOCK FUNCTION

Use the Key Lock function to prevent any changes to your settings (in a child's room, public area... etc.)

- To activate the Key Lock function, slide the switch (E, figure 6), to the left , then to the right , then back to the left . Repeat this sequence 3 times.



- LED A & C will both flash orange 5 times.
- Repeat the same procedure to unlock the keypad.

Note: When unlocking the Key Lock function, LED A & C will flash orange during the unlock sequence. When successfully unlocked, LED A & C will flash green 5 times.

Note: If any alterations are made to dials B or D, or to switch E, when the Key Lock is active, LED A & C will flash orange 5 times to indicate the Key Lock is active.

This function is available in all operating modes.

8.0 Parameter Menu

MYSON Finesse radiators work best as a stand alone radiator or connected to a TOUCH4 Programmer for Central Programming control.

Should you require to programme your Finesse radiator independently, please go to www.myson.co.uk/Finesse for the full instructions on how to do this.

9.0 Radiator Connected to the TOUCH4 Programmer

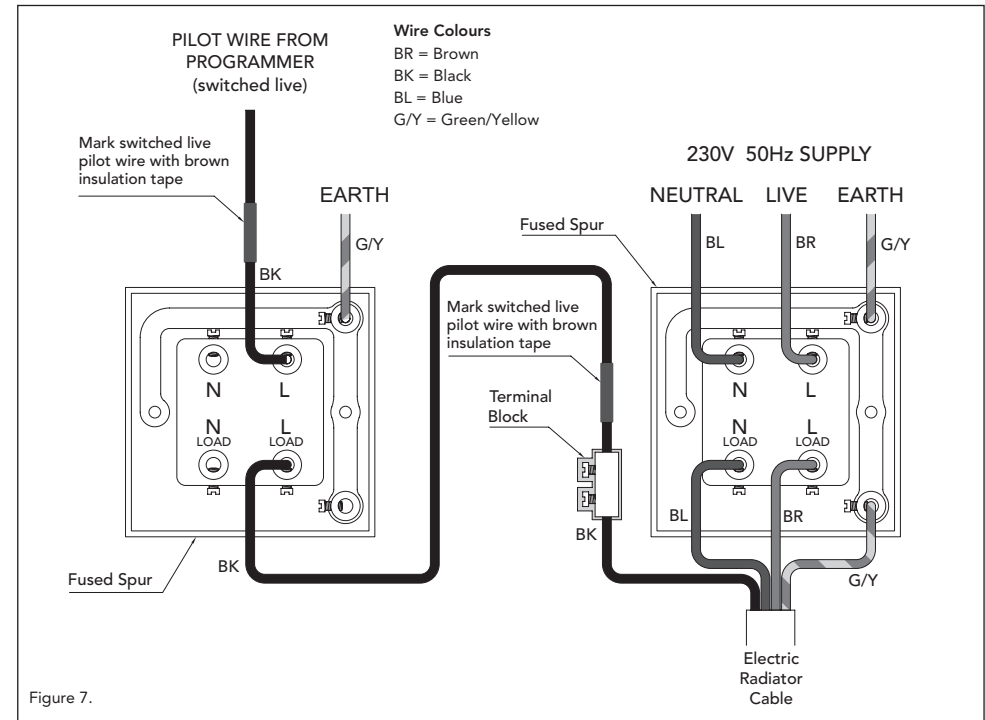

Figure 7.

When connected to the TOUCH4 (figure 7), select the automatic operation mode.

AUTOMATIC MODE

- A suitable means of local isolation of the radiator from both the electrical supply and the pilot wire signal must be provided.
- The fused spurs must be clearly marked to indicate that two sources of electrical supply may be present.



- Select the desired room temperature during periods of normal occupancy between 5 and 30°C using dial "B".

9.0 Radiator Connected to the TOUCH4 Programmer (cont...)

- Rotate dial "D" within the area covered by the ☉ symbol. The value on this scale indicates the desired temperature reduction during the night or during shorter periods of absence.
- When the house is unoccupied for longer periods (e.g. holiday) you can override the clock programme by rotating dial "D" around to "Reduced" or "Frost protection" mode.
- The section highlighted with ☉ symbol should only be used when connected to the TOUCH4. If the radiator is set in this position when not connected, then it will only work in comfort mode ☀.
- The TOUCH4 has an IP20 rating.

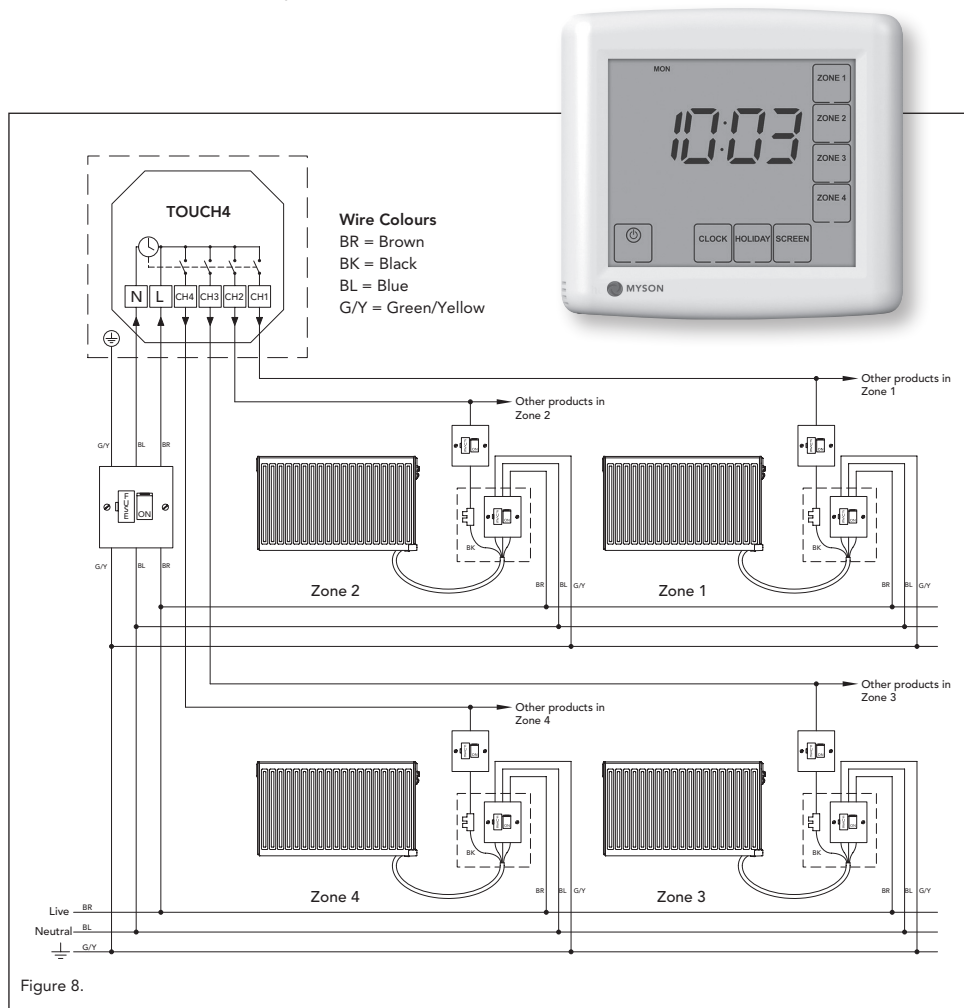

When installing in a bathroom or wet room, please refer to the installation positions in Section 4.0 Installation on page 6.

10.0 Technical Characteristics

ENVIRONMENT: - Operating temperature - Transportation and storage temperature	-30°C to +50°C -30°C to +70°C
RANGES FOR TEMPERATURE SETTINGS: - Comfort mode - Reduced mode - Frost protection mode	+5°C to +30°C Temp reduction between -3.5°C and -15°C +7°C
ELECTRICAL INSULATION	Class I
ELECTRICAL PROTECTION	IP44
POWER SUPPLY	230 VAC - 50 Hz
DIRECTIVES & STANDARDS: The product has been designed to comply with the following Directives and Standards.	<ul style="list-style-type: none"> • EN 60730-1 • EN 60335-1 • EN 60335-2-30 • EN 62233 • EN 55014-1 • EN 55014-2 • EN 61000-3-2 • EN 61000-3-3 • EN 60529 • LV Directive 2006/95/EC • EMC Directive 2004/108/EC • RoHS Directive 2002/95/EC • ECO Directive 2009/125/EC

11.0 Eco Directive Characteristics

Model identifier(s): FExxxxxx where "x" may be any character.

Item	Symbol	Value	Unit
Heat Output			
Nominal heat output where "xxxxxx" = 30DX50 or 50DX40	P_{nom}	0.50	kW
Nominal heat output where "xxxxxx" = 30DX80 or 50DX50	P_{nom}	0.75	kW
Nominal heat output where "xxxxxx" = 30DX100 or 50DX65	P_{nom}	1.00	kW
Nominal heat output where "xxxxxx" = 30DX130 or 50DX80	P_{nom}	1.25	kW
Nominal heat output where "xxxxxx" = 30DX160 or 50DX95	P_{nom}	1.50	kW
Nominal heat output where "xxxxxx" = 30DX200 or 50DX125	P_{nom}	2.00	kW
Minimum heat output (indicative)	P_{min}	N.A.	kW
Nominal heat output where "xxxxxx" = 30DX50 or 50DX40	$P_{max,c}$	0.50	kW
Nominal heat output where "xxxxxx" = 30DX80 or 50DX50	$P_{max,c}$	0.75	kW
Nominal heat output where "xxxxxx" = 30DX100 or 50DX65	$P_{max,c}$	1.00	kW
Nominal heat output where "xxxxxx" = 30DX130 or 50DX80	$P_{max,c}$	0.25	kW
Nominal heat output where "xxxxxx" = 30DX160 or 50DX95	$P_{max,c}$	1.50	kW
Nominal heat output where "xxxxxx" = 30DX200 or 50DX125	$P_{max,c}$	2.00	kW
Auxiliary electricity consumption			
At nominal heat output	$e_{l,max}$	0.00	kW
At minimum heat output	$e_{l,min}$	N.A.	kW
In standby mode	$e_{l,SB}$	<0.001	kW

11.0 Eco Directive Characteristics (cont...)

Item	Unit
Type of heat input, for electric storage local space heaters only	
Manual heat charge control with integrated thermostat	N.A.
Manual heat charge control with room and/or outdoor temperature feedback	N.A.
Electronic heat charge control with room and/or outdoor temperature feedback	N.A.
Fan assisted heat output	N.A.
Type of heat output/room temperature control	
Single stage heat output and no room temperature control	No
Two or more manual stages, no room temperature control	No
With mechanic thermostat room temperature control	No
With electronic room temperature control	No
Electronic room temperature control plus day timer	No
Electronic room temperature control plus week timer	Yes
Other control options	
Room temperature control, with presence detection	No
Room temperature control, with open window detection	Yes
With distance control option	No
With adaptive start control	Yes
With working time limitation	No
With black bulb sensor	No